

# OSMO

## User Manual

V1.0 2015.11

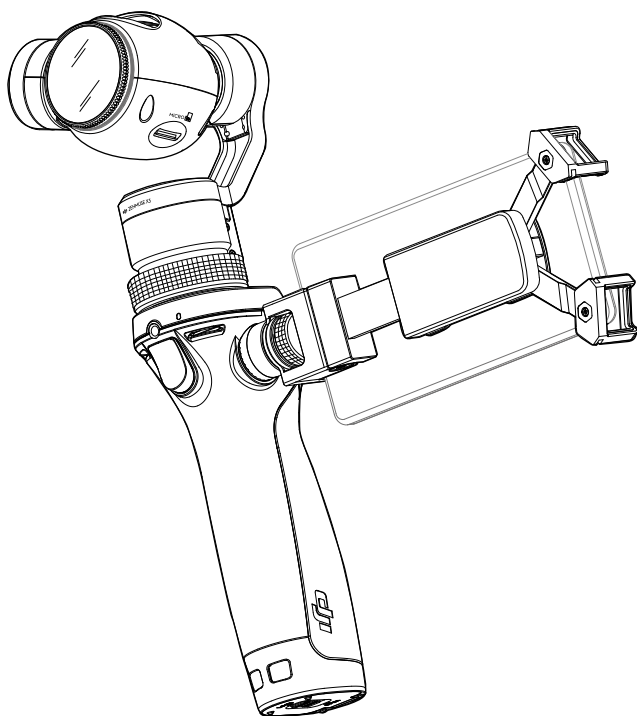

### **Searching for Keywords**

Search for keywords such as “battery” and “install” to find a topic. If you are using Adobe Acrobat Reader to read this document, press Ctrl+F (Windows) or Command+F (Mac) to begin a search.

### **Navigating to a Topic**

View a complete list of topics in the table of contents. Click on a topic to navigate to that section.

## Using this Manual

### Legend

 Important

 Tips

### Install the DJI GO App

Search for ‘DJI GO’ on the App Store or Google Play and install the app on your mobile device.



---

 DJI GO supports iOS 8.0 (or later) or Android 4.1.2 (or later).

---

# Contents

<b>Using this Manual</b>	2
Legend	2
Install the DJI GO App	2
<b>Introduction</b>	4
<b>Getting Started</b>	5
Intelligent Battery	5
Mounting your Mobile Device	7
Removing the Mobile Device Holder	8
External Mounts	8
Unlocking the Gimbal	9
Locking the Gimbal	10
<b>Using the Osmo</b>	10
Controls and Operations	10
Operation Modes	13
Compatibility with the Zenmuse X3 for the Inspire 1	15
<b>DJI GO App</b>	15
Download	15
Connecting to the DJI GO App	15
Key Pages	16
<b>Upgrading the Firmware</b>	21
Using the DJI GO App	21
Using a Micro SD Card	22
<b>Maintenance</b>	22
<b>Specifications</b>	23
<b>Troubleshooting</b>	25

# Introduction

The Osmo is a 3-axis handheld gimbal and camera that can capture 12MP still photos and 4K video with onboard or external sound recording. Its light and ergonomic design with buttons at your fingertips form a powerful and personal one-handed filming device. The DJI GO app complements the Osmo with shooting modes such as timelapse, auto panorama, long exposure and slow motion.

Equipped with 3-axis stabilization and SmoothTrack technology, the gimbal compensates for natural arm movements and smooths out transitions. Finer operations can be done with the joystick, while instant positioning of the camera can be made directly with your other hand. The camera tilts across a 170 degree range and has a pan rotation of 640 degrees.

The DJI Rosette Mount on the side of the handle allows your mobile device to be mounted as a live HD viewfinder, and supports external devices including vehicle mounts and tripods for specialized filming applications.

## At a Glance:

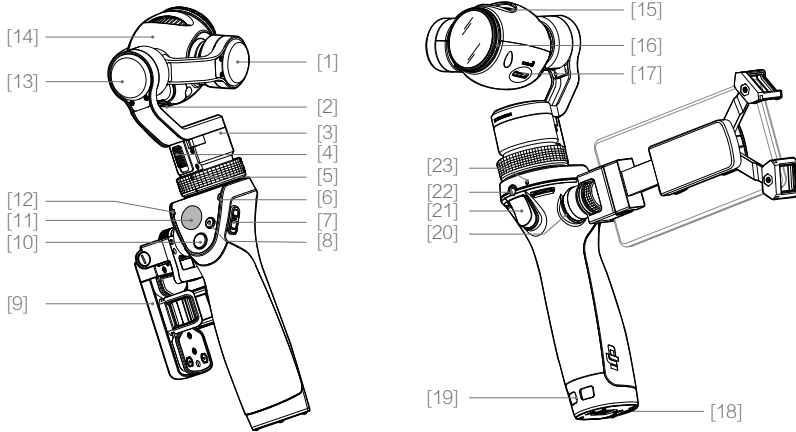

- |                             |                              |                                |
|-----------------------------|------------------------------|--------------------------------|
| [1] Tilt Motor              | [9] Mobile Device Holder     | [17] Micro SD Card Slot        |
| [2] Micro USB Port          | [10] Shutter Button          | [18] Battery Cover             |
| [3] Pan Motor               | [11] Joystick                | [19] Lanyard Hole              |
| [4] Pan Axis Lock           | [12] Camera Status Indicator | [20] DJI Rosette Mount         |
| [5] Gimbal Lock             | [13] Roll Motor              | [21] Trigger                   |
| [6] System Status Indicator | [14] Camera                  | [22] External Microphone Input |
| [7] Power Switch            | [15] Air Vents               | [23] Built-in Microphone       |
| [8] Record Button           | [16] UV Filter               |                                |

# Getting Started

## Intelligent Battery

The 980 mAh Intelligent Battery can power the Osmo for about 65 minutes.

### Intelligent Battery Functions

Battery Balancing	Balances the voltage of each cell during charging.
Overcurrent Protection	Stops charging if the charging current is too large.
Overcharge Protection	Stops charging if its voltage is too high.
Over-discharge Protection	Stops discharging if its voltage is too low.
Short Circuit Protection	Cuts the power supply if a short circuit is detected.
Temperature Control	Stops charging if the core temperature falls below 59°F (15°C) or exceeds 104°F (40°C).
Battery Level Display	The battery level is displayed in the DJI GO app.

### Battery Specifications

Model	HB01-522365
Type	LiPo
Capacity	980 mAh
Energy	10.8 Wh
Voltage	11.1 V
Charging Temperature	59° to 104° F (15° to 40° C)
Operating Temperature	14° to 122° F (-10° to 50° C)

- ⚠ • Be sure to fully charge the Intelligent Battery for the first time to activate it.
- Read the user manual, Intelligent Battery Safety Guidelines before use. The user takes full responsibility for all operations and usage.

### Charging the Battery

Connect the battery charger to a power outlet using the provided cable. The LED indicator on the battery charger will glow green.

Place the battery into the battery charger. The LED indicator will become red when charging. It will take approximately an hour for the battery to be fully charged, at which point the LED indicator will change from red to green.

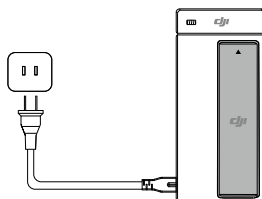

## Battery Charger Specifications

Model	SOY015A-1260120
Input	100-240 V, 50/60 Hz
Output	12.6 V, 1.2 A

- ⚠ • Only charge the battery with the provided battery charger. DJI takes no responsibility for accidents caused by the use of non-DJI battery chargers.
- Remove the battery from the charger unless it is charging to prevent battery discharging.

## Inserting the Battery

Slide the locking switch at the base of the Osmo to open the battery cover. Insert the battery and lock the battery cover.

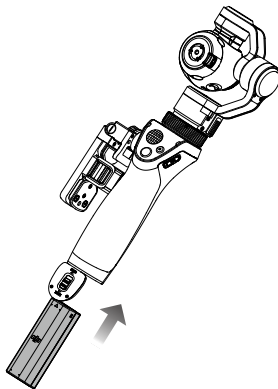

## Removing the Battery

Slide the locking switch at the base of the Osmo to open the battery cover. Push the red safety hook away from the battery to let it pop up, and then remove the battery.

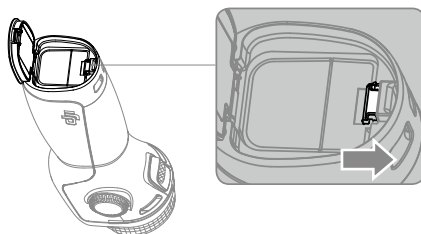

## Mounting your Mobile Device

1. Unfold the two arms on the mobile device holder.
2. Adjust the pads to the desired position.

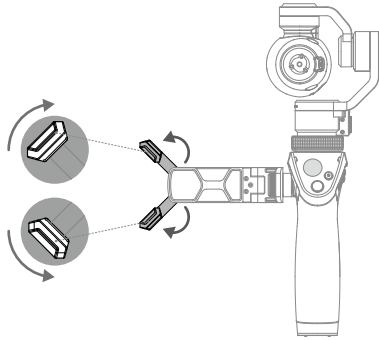

3. Place one end of your mobile device into the arms.
4. Extend the arms so that your entire mobile device is seated in the mobile device holder.

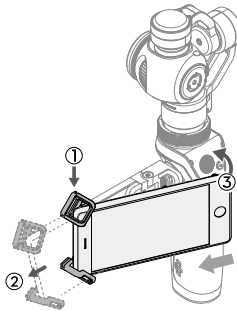

5. Rotate your mobile device to the desired position.

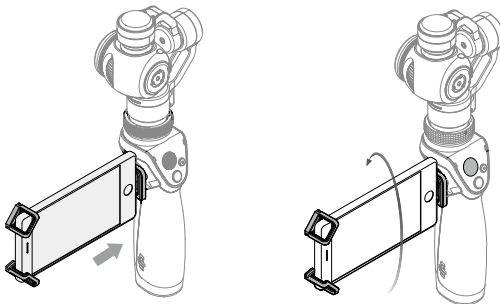

## Removing the Mobile Device Holder

The mobile device holder can be removed by rotating the knob counterclockwise. It is recommended to install the cap for the DJI Rosette Mount when it is not in use.

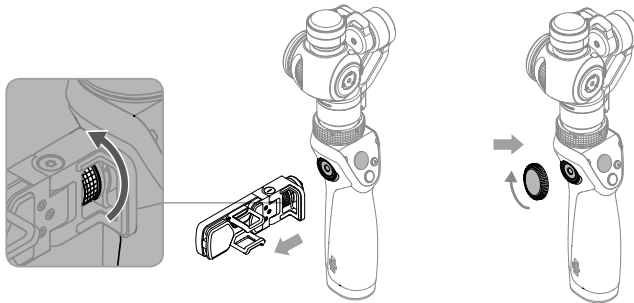

Getting Started

## External Mounts

Different types of external mounts can be attached to the DJI Rosette Mount for unique applications.

### Universal Mount

Used to mount external devices such as a microphone or flashlight.

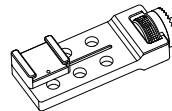

### Extension Rod

Good for taking group selfies, overhead shots or reaching into small spaces.

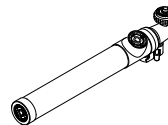

### Tripod

For stationary shots that require steady footage.

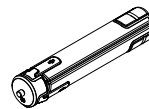

### Bike Mount

Used to mount the Osmo on a bicycle.





## Vehicle Mount

Triple suction cup mount makes it ideal for mounting on top of or on the rear window of moving vehicles.



## Straight Extension Arm

Used to attach up to three other mounts at the same time.

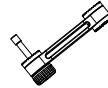

☀️ • Visit the official DJI Store (<http://store.dji.com>) to learn more.

## Unlocking the Gimbal

To protect the gimbal, the three motor axes are locked in place. To unlock the gimbal:

1. Gently rotate the tilt motor until it can rotate freely. Similarly, rotate the roll motor.

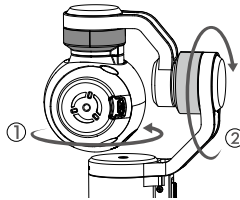

- ⚠️ • Be sure to unlock the tilt motor before unlocking the roll motor to avoid damaging the camera lens.
- Rotate the motors just enough to allow free motion.

2. Slide the Pan Axis Lock upwards to unlock the pan axis.

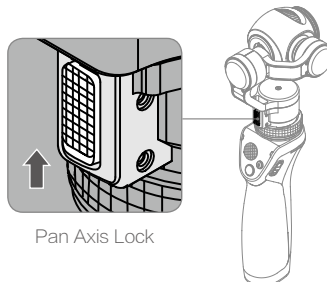

- 
- ⚠ • You can choose to unlock the gimbal before or after the Osmo is turned on. It is recommended to unlock the gimbal before powering on the Osmo.
  - The Osmo will beep slowly if the gimbal is locked after it is turned on. This means the camera is working normally but the gimbal is shut off.
  - If you need to unlock the gimbal after it is turned on, you must rotate the pan motor after unlocking the tilt motor and pan motor to reactivate the gimbal.
- 

## Locking the Gimbal

Pull the pan axis lock down and rotate the pan axis to the locked position (until it cannot rotate any further), and then adjust the roll motor and tilt motor in order to lock them in place.

- 
- ⚠ • You can lock and unlock the gimbal while the Osmo is turned on. Quickly tap the trigger twice to reactivate the motors after they are unlocked.
- 

# Using the Osmo

## Controls and Operations

The gimbal anticipates handle movement to smooth out pan and tilt transitions, and uses SmoothTrack technology to reduce camera shakes from natural arm movements. Additionally, there are buttons on the front and back of the handle that allow for finer control over the gimbal and camera. All of the buttons and controls are described below.

### [1] Power Switch

To turn on the Osmo, pull the power switch down and then release it.

Pulling the power switch again will cause the Osmo to go in or out of sleep mode.

To turn off the Osmo, pull the power switch down and hold for 1.5 seconds.

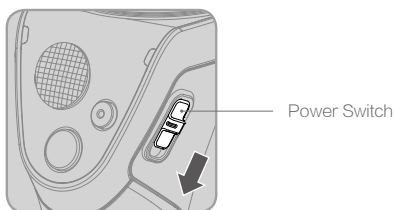

- 
- ⚠ • Hold the Osmo steady and upright while it is starting up.
-

**[2] Joystick**

Vertical movement tilts the camera. Horizontal movement pans the camera.

**[3] Shutter Button**

Press this button to take photos based on your settings in the DJI GO app.

**[4] Record Button**

Press this button once to start recording video, and again to stop recording.

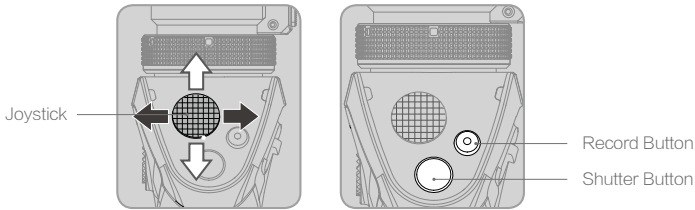
**[5] Camera Status Indicator**

Indicates the camera's system status. Refer to the table below for details.

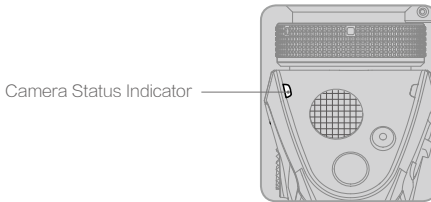





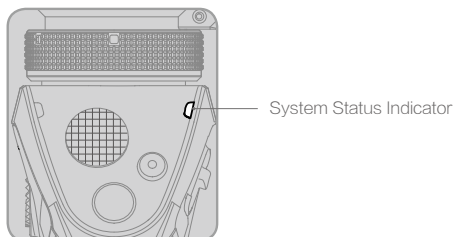

Blinking Pattern	Description	
○ LED Off	Camera is functioning normally.	
⦿ ·····	Blinks Green	Shooting photo.
⦿ ······	Blinks Green slowly	Self-timer.
⦿ ··· ··· ···	Blinks Green for each shot	Burst shooting.
⦿ —	Solid Green	Firmware upgrade successful.
⦿ ·····	Blinks Red slowly	Recording video.
⦿ / ⦿ ·····	Blinks Red and Green alternately	Upgrading firmware.
⦿ —	Solid Red	Camera is not mounted on the Osmo properly / Firmware upgrade failed or system error.
⦿ x2 ·····	Blinks Red twice	Camera error.
⦿ ·····	Blinks Yellow	Micro SD card busy.
⦿ —	Solid Yellow	Micro SD card error.

## [6] System Status Indicator

Indicates the status of the Osmo. Refer to the table below for details.



System Status Indicator	Description
 ..... Blinks Green quickly	The Osmo is initializing / Exiting sleep mode.
 ..... Blinks Red slowly	Low battery level warning.
 ..... Blinks Red quickly	Critical low battery level warning.
 — Solid Yellow	The trigger is tapped and the gimbal is in lock mode.
 — Solid Red	Non-DJI battery detected.
 — Breathing Green (high battery level)	The Osmo is in sleep mode.
 — Breathing Red (low battery level)	

## [7] Trigger

Hold down the Trigger to enable Lock Mode. The camera will stay in its current position regardless of handle movement. The Osmo will return to SmoothTrack Mode once the Trigger is released.

Quickly tap the Trigger twice to center the camera. When the Osmo is in Upright Mode and Underslung Mode, quickly tapping the Trigger three times will enter Selfie Mode.

## [8] External Microphone Input

Connect a 3.5 mm external microphone to record high quality audio.

## [9] Built-in Microphone

Records audio for general use. You can turn off the microphone in the DJI GO app.

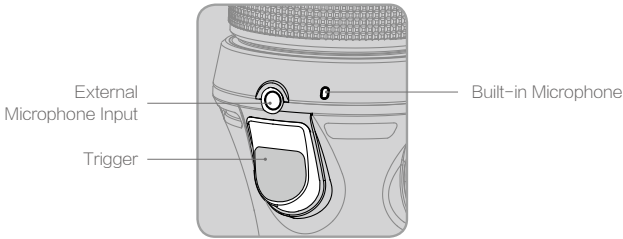

- ⚠ • The external microphone will override audio reception of the built-in microphone.
- It is normal for the built-in microphone to pick up some noise from the gimbal motors.

#### [10] Restore Default Wi-Fi Settings

Hold down the Trigger and Shutter Button at the same time. Then, pull the power switch down until the System Status Indicator blinks green. Release the power button before releasing the Trigger. The default SSID, password and frequency for the Wi-Fi connection will be restored.

## Operation Modes

### Upright Mode

Upright Mode can be used without any user input. In this mode, quickly tap the trigger twice to center the camera.

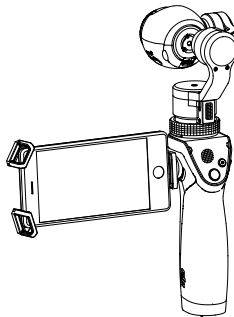

Quickly tap the trigger three times and the camera will point at you, ready for a selfie.

## Underslung Mode

Holding the Osmo upside down will cause it to enter Underslung Mode, in which the camera can easily capture images from a lower position. Quickly tapping the trigger twice will center the camera.

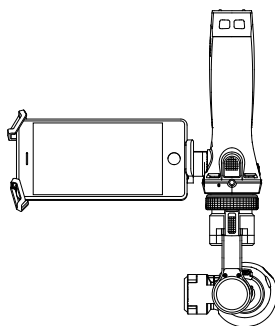

Quickly tap the trigger three times and the camera will point at you, ready for a selfie.

## Flashlight Mode

Rotate the Osmo forward 90 degrees to go from Upright Mode to Flashlight Mode. Quickly tapping the trigger twice will center the camera.

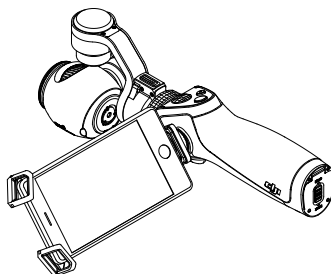

In Flashlight Mode, pushing the joystick will allow the camera to pan left or right.

## Portrait Mode

Rotate the Osmo 90 degrees to the left or right to go from Upright Mode to Portrait Mode.

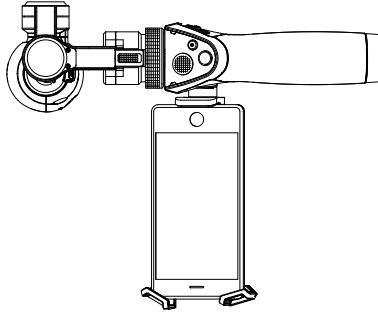

## Compatibility with the Zenmuse X3 for the Inspire 1

The Osmo is compatible with the Zenmuse X3 Gimbal and Camera that comes with the Inspire 1. Be sure to upgrade the Zenmuse X3 with the latest firmware (to be released soon after this manual) before mounting it onto the Osmo handle.

## DJI GO App

Watch a live HD video feed on your mobile screen through the DJI GO app. The app also allows you to configure camera and gimbal settings in just a few taps.

### Download

Search 'DJI GO' on the App Store or Google Play and download the app to your mobile device.

### Connecting to the DJI GO App

1. Turn on the Osmo. Hold the handle still and avoid touching the gimbal while the Osmo starts up.

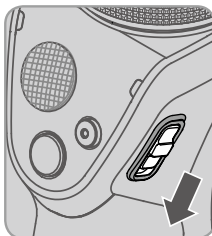

- On your mobile device, connect to the 'OSMO\_XXXXXX' Wi-Fi network and enter the default password 12341234. Then launch the DJI GO app.

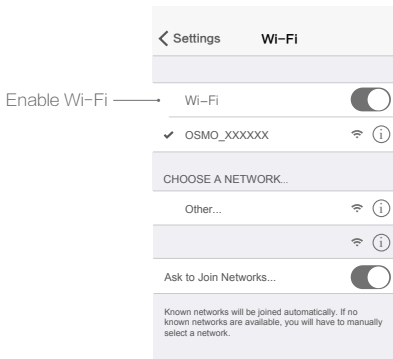

- If you are using the Osmo for the first time, follow the on-screen instructions to activate it. You will need to log in to your DJI account through an Internet connection. Re-connect to the Osmo Wi-Fi network after the activation is complete.
- Enter Camera View. You will see what the camera captures in real time if it is connected successfully.

 • There will be a tutorial on how to use your Osmo after entering the camera view.

## Key Pages

### 1. Equipment > Camera





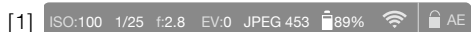

### Information Bar

Displays the camera parameters, current battery level, and Wi-Fi signal strength.

### [2] : Photo/Video Toggle

Slide to switch between photo and video mode.

### [3] Photo/Video Settings

#### : Photo Modes

##### • Single Shot

Normal, 5s or 10s delayed shot, HDR.

##### • Multiple Shots

Burst shooting 3/5/7 frames, Auto Exposure Bracketing (AEB) 3/5 bracketed frames at 0.7EV Bias.

##### • Panorama

Auto: The camera will rotate 360 degrees and render a panorama.

Selfie: The camera will point at you, pan 180 degrees and render a panorama.

##### • Interval Timer

5s, 10s or 30s intervals.

##### • Timelapse

1) Choosing to store timelapse in 'JPEG+Video' format limits the minimum interval to 2 seconds. Disabling this option reduces the minimum interval to 1 second.

2) If the timelapse interval is 2 seconds or more, the camera will apply digital stabilization to the live HD video on your mobile device.

#### : Video Modes

##### • Auto: Normal video based on your camera settings.

##### • Slow Motion: Recorded at 1080p and 120fps.

### [4] : Shutter/Record Button

Shoots photos in photo mode and records video in video mode.

### [5] : Camera Parameters

Choose the shooting mode, ISO, shutter speed and exposure value.

### [6] : Playback

Tap to view photos and videos on the Micro SD card.

### [7] : Time Bar

Display the current recording time and remaining recording time.

[8]  : Settings**Camera Settings**

Here you can select the output formats for photos, video recording and sound recording, and enable on-screen displays such as grids and the histogram. Some of these options are explained below.

**• Record Audio**

Enable this option if you want to record sound through the built-in microphone or an external microphone. The external microphone will override the built-in microphone.

**• Video Caption**

If you enable this option, a .srt file containing on-screen information will be created with the video file.

**• Timelapse Format**

Choosing 'JPEG+Video' will save the timelapse photos as well as the video.

**• Anti-Flicker**

Select the frequency that matches the current cycle in your country to prevent the flickering of lights.

**• File Index Mode**

If you select 'Reset', the camera will write the photo and video files starting from the smallest available index. If you select 'Continuous', the camera will continue the index from the last written file.

**Gimbal Settings****• Profiles**

Select the 'Fast', 'Medium' or 'Slow' profile depending on how responsive you want the gimbal to be. Alternatively, create a custom profile by selecting C1 or C2 and configuring the settings below.

**• SmoothTrack Settings**

The pan and tilt axes can be adjusted separately.

Speed: Determines how fast the gimbal will catch up with the translated pan/tilt handle movement.

Deadband: A larger deadband requires more pan/tilt handle movement to translate into gimbal motion.

Acceleration: Determines how closely the camera will follow the translated pan/tilt handle movement.

**• Joystick Settings**

Smoothing: Controls the deceleration of the gimbal. A small value will cause the gimbal to stop abruptly.

Speed: Controls the movement speed of the tilt and pan axes when controlled by the joystick.

- **Horizontal Calibration**

You may have to calibrate the roll axis if the camera's horizon level is not perfectly level by setting a positive or negative value.

- **Auto Calibration**

Reduces the drift caused by magnetic interference in the surroundings or human error. Hold the Osmo still and upright during the calibration.

- **Reset Gimbal**

Tap to reset the gimbal to the default settings.

### General Settings

Here you can change the Wi-Fi password, clear the video cache, format your Micro SD card or view the current firmware version.

[9] : **White Balance**

Tap to adjust the white balance of your photo or video.

[10] : **Gimbal Functions**

Tap  enable Lock Mode. Tap  to recenter the camera.

[11] : **Home**

Tap to navigate to the home screen.

### Drag Focus

In Camera View, touch the screen and hold until a blue circle appears. Then, drag the circle to control the camera.

## 2. Library

View, edit and share your masterpieces all in one place. The Library has a range of simple but powerful tools that let you edit your videos and photos before sharing them online, minutes after they are captured.



Once you login or register your DJI account, you will be able to conveniently upload and share your creations. The saved photos and videos can be uploaded to Skypixel ([www.skypixel.com](http://www.skypixel.com)) and shared on social networks such as Facebook, Twitter, WeChat, Moments and Sina Weibo.

### Video

All of your recorded video footage will appear in 'Original Footage'. You can trim footage and save it to 'Create Movie'. Then, select multiple clips to create a movie quickly with the built-in editing tools and templates.

### Photos

Edit your photos by adjusting the parameters, editing the photo size, adding watermarks and applying filters.

## 3. Explore

Learn more about the latest DJI events, featured products and trending Skypixel uploads on the Explore page.

## 4. Me

If you already have a DJI account, you will be able to participate in forum discussions, earn DJI Credit for the DJI Official Store, and share your masterpieces with the community.

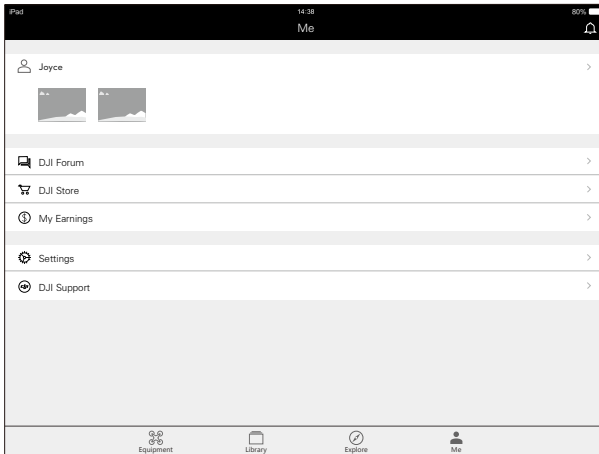

## Upgrading the Firmware

Ensure that the battery has at least 50% power. It will take approximately 20 minutes to complete the upgrade. It is recommended to lock the gimbal and place the handle on a flat surface during the upgrade process.

The camera status indicator will blink green and red alternately during the upgrade process, and become solid green when the firmware upgrade is complete. If the upgrade is unsuccessful, the camera status indicator will become solid red, in which case you should reattempt the upgrade.

### Using the DJI GO App

Connect the Osmo to your mobile device and then launch the DJI GO app. You will be reminded if a new firmware upgrade is available. To start upgrading, connect your mobile device to the internet and follow the on-screen instructions.

- 
- ⚠ • A Micro SD card must be inserted into the Osmo for the upgrade to start.
-

## Using a Micro SD Card

1. Download the latest firmware update package from the product page on the official DJI website.
2. Copy the .bin file to the root directory of your Micro SD card (ensure there is enough storage), and insert the card into the Micro SD card slot on the camera while the Osmo is powered off.
3. Power on the Osmo to begin upgrading.

Read the .txt file on the root directory of the Micro SD card to confirm the upgrade result.



- Restart the Osmo and ensure the Camera Status Indicator is off for normal use.
- 

## Maintenance

When transporting the Osmo, keep it locked, in order to protect the gimbal, as shown below.

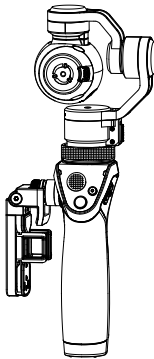

The Osmo is not water resistant. Keep it away from sand and dust during use. After use, it is recommended to wipe the Osmo down with a soft dry cloth. Never spray any cleaning liquids onto the Osmo.

# Specifications

<b>Handle</b>	
Dimensions	2.4×1.9×6.4 inches (61.8×48.2×161.5 mm)
Weight (including battery)	201 g
<b>Gimbal</b>	
Model	Zenmuse X3
Weight	221 g
Output Power (with camera)	Static: 9 W; Dynamic: 11 W
Angular Vibration Range	±0.03°
Mount	Detachable
Controllable Range	Tilt: -35° to +135°
	Pan: ±320°
	Roll: +30° to -30°
Mechanical Range	Tilt: -90° to +150°
	Pan: ±330°
	Roll: -50° to +90°
Max Controllable Speed	120°/s
<b>Camera</b>	
Model	X3/FC350H
Sensor	Sony Exmor R CMOS
	1/2.3"
	Effective pixels: 12.40 M (Total pixels 12.76 M)
Lens	94° FOV 20 mm (35 mm format equivalent)
	f/2.8
	Focus: 3.5 m (Suitable Range: 1.5 m to infinity)
ISO Range	100–3200 (video)
	100–1600 (photo)
Electronic Shutter Speed	8 s–1/8000 s (up to 30 s when camera is in M mode)
Max. Image Size	4000 x 3000 pixels
Still Photography Modes	Single Shot
	Photo Burst Mode: 3/5/7 shots
	Auto Exposure Bracketing (AEB):
	3/5 bracketed frames @ 0.7EV bias
	Interval
	Timelapse
	Auto Panorama
Selfie Panorama	

Video Resolution	UHD: 4K (4096×2160) 24/25p
	4K (3840×2160) 24/25/30p
	2.7K (2704×1520) 24/25/30p
	FHD: 1920×1080 24/25/30/48/50/60/120p
	HD: 1280×720 24/25/30/48/50/60p

Video Recording Modes	Auto
	Slow Motion

Max. Video Bitrate	60 Mbps
--------------------	---------

Supported File Systems	FAT32 (≤ 32 GB)
	exFAT (> 32 GB)

Photo Formats	JPEG, DNG (RAW)
---------------	-----------------

Video Formats	MP4, MOV (H.264 / MPEG-4 AVC)
---------------	-------------------------------

Supported SD Cards	Micro SD
	Max. Capacity: 64 GB
	Class 10 or UHS-1

Operating Temperature	32° to 104° F (0° to 40° C)
-----------------------	-----------------------------

Audio Output	Two channel
	48 kHz
	AAC

### Wi-Fi Video Link

Operating Frequency	2.412–2.462 GHz
	5.180–5.805 GHz

Max Transmission Distance	82 feet (25 m)
---------------------------	----------------

Transmitter Power (EIRP)	2.4 GHz: 8 dBm
	5 GHz: 12 dBm

### Intelligent Battery

Model	HB01-522365
-------	-------------

Type	LiPo
------	------

Capacity	980 mAh
----------	---------

Energy	10.8 Wh
--------	---------

Voltage	11.1 V
---------	--------

Charging Temperature	59° to 104° F (15° to 40° C)
----------------------	------------------------------

Operating Temperature	14° to 122° F (-10° to 50° C)
-----------------------	-------------------------------

### Battery Charger

Model	SOY015A-1260120
-------	-----------------

Input	100–240 V, 50/60 Hz
-------	---------------------

Output	12.6 V, 1.2 A
--------	---------------



# Troubleshooting

## 1. Why can't I connect to the Osmo?

- Check your mobile device's Wi-Fi settings to make sure it is connected to the Osmo's Wi-Fi network.
- If the Osmo's Wi-Fi network does not appear in your phone's Wi-Fi settings, make sure your mobile device is operating at either the 2.4GHz or 5.8GHz channel and try again.
- If you still cannot connect to the Osmo even though your mobile device is connected to the Osmo's Wi-Fi network, restart the Osmo and try again.

If the problem persists, reset the Osmo's Wi-Fi network to its default settings by using the key combination and try again. (Key combination: Hold down the Trigger and Shutter Button at the same time. Then, pull the power switch down until the System Status Indicator blinks green. Release the power button before releasing the Trigger.)

Still can't connect? You can contact our online support at [www.dji.com/support](http://www.dji.com/support) to get more help.

## 2. Why doesn't the gimbal work out of the box?

Ensure you have activated the Osmo by linking it to your DJI account. Connect your mobile device to the dedicated Osmo Wi-Fi network, launch the DJI GO app, and then follow the on-screen instructions to activate the device.

## 3. Why does the Osmo keep beeping after I turn it on?

The gimbal is locked. Rotate the tilt and roll axes until they can move freely. If the pan axis is locked, slide the Pan Axis Lock up to free the pan axis.

## 4. What should I do if the battery depletes while I am recording video?

Do not remove the Micro SD card from the camera. Recharge the battery or insert a new one into the handle. The Osmo will automatically recover the video file when it starts up.

## 5. How do I shoot amazing long exposure shots?

Long exposures can be produced by setting a slow shutter speed. In the DJI GO app, choose 'S' mode (Shutter Priority) or 'M' (Manual Mode) and adjust the shutter speed to the desired value. Make sure you hold the camera still for the entire shutter duration.

## 6. Can I close the DJI GO app or disconnect my mobile device while the Osmo is recording video?

Yes. The Osmo will continue recording video and still be able to capture photos, but you will lose the ability to preview the shots on your mobile device.

**7. The cameras for the Osmo and the Inspire 1 look similar. Are they interchangeable?**

No. The mechanical structure of the Osmo's camera is designed for hand held use. The 3-axis gimbal can be flattened and locked, and the position of the tilt motor is different. However, the Inspire 1's camera can be used with the Osmo after it is upgraded with the latest firmware (to be released soon).

This content is subject to change.

**Download the latest version from  
[www.dji.com/product/osmo](http://www.dji.com/product/osmo)**



If you have any questions about this document, please contact DJI by sending a message to [DocSupport@dji.com](mailto:DocSupport@dji.com).